



SEMICONDUCTOR  
PRODUCTS GROUP

# Polycold® PFC

## Fast Cycle Water Vapor Cryopump

VACUUM PRODUCTS



Marked for European Application  
Refrigerants Compliant to EC  
2037/2000, the Montreal protocol,  
and the us epa snap

### Benefits

- -90° to -140°C (183 to 133 K)
- Heat Removal to 3600 Watts
- Cryocondenses Water Vapor in Vacuum Systems with Speeds to 200,000 l/sec Vacuum Levels to  $1.5 \times 10^{-9}$  torr ( $2 \times 10^{-9}$  mbar)
- Provides very fast pumping speeds for water vapor, which is typically 65% to 95% of the gas load in high vacuum systems.
- Green refrigerant charge is globally compliant, non-toxic, and non-flammable
- Based on Polycold's proven, innovative, dependable mixed-gas cryogenics
- ISO 9001:2000 certified manufacturer

The Polycold Fast Cycle Water Vapor Cryopump (PFC) effectively captures water vapor, which comprises 65% to 95% of the residual gas in high-vacuum systems. Water vapor is typically the most reactive contaminant present. With the PFC 1102, you can expect to increase product throughput in your existing system 20% to 100% and improve quality of deposition.

### *The PFC Advantage*

- High-vacuum pumpdown time cut by 25% to 75%
- High-speed pumping of water vapor: 10,000 to 200,000 l/sec in the workspace
- Increased product throughput of 20% to 100%
- Typical payback times of less than one year
- Lower water vapor partial pressure during processing for higher film quality, better adhesion and more reproducible deposition
- Superior in cost/performance to liquid nitrogen cooled Meissners

When added to your vacuum system, the PFC Cryopump can dramatically reduce pumpdown times and increase product throughput. The PFC will pump water vapor within minutes from “start” and can defrost in less than four minutes, giving true fast-cycle capability. For your system, this means more production cycles per shift. Pumpdown times are typically reduced by 25% to 75%, and increases in product throughput are 20% to 100%.

Using Polycold's patented cryogenic refrigeration process, and patented refrigerant mixtures, the PFC works on the principle of Meissner trapping. Water vapor is captured by condensation on a cryogenically cooled surface, called a Meissner coil. The Meissner (cryocoil) is mounted directly in the vacuum chamber so conductance is not limited by ports, manifolds, valves and baffles. The cryocoil is easy to install and can be adapted to fit any system. It does not need a high-vacuum valve.

PFC Cryopumps are the most cost-effective pumping upgrade you can add to any diffusion-pumped, turbo-pumped or helium-cryopumped system. A control module allows you to have either local or remote operation, enabling you to operate the PFC from your existing controller or processor.

The PFC is available in a variety of capabilities and cryocoil configurations. Models are available that control two cryocoils or the combination of a cryocoil and a baffle. Please refer to Product Specifications and to our PFC Price List for price and option details.

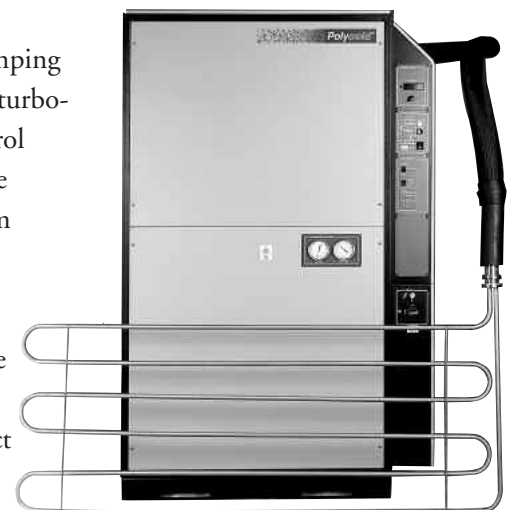

Polycold® PFC 1102

## Selection and Application

*How do I select the right size PFC unit to trap water vapor in my vacuum chamber?*

Determining the appropriate PFC system depending upon the desired water vapor pumping speed and the ability of the chamber to accommodate the required amount of cold element (cryocoil) surface area. The larger the cryocoil, the greater the pumping speed. Typically, we recommend an increase in chamber net speed of four times the existing (net in-chamber) water vapor pumping speed. This typically results in a pumpdown time reduction of from 25% to 75%. Once the approximate unit size and cryocoil surface area have been established, the required temperature and cooling capacity of the system are reviewed against the presence of any additional heat load (long refrigerant lines, process heat, etc.).

*What's the best temperature to trap water vapor effectively?*

To find the cryosurface temperature that is best for your vacuum system, find the ultimate base pressure of your system listed below. Then follow across to the right column which shows the required cryosurface temperature. This temperature provides 90% water vapor trapping efficiency.

DESIRED WATER VAPOR PARTIAL PRESSURE		AVERAGE CRYOSURFACE TEMPERATURE NEEDED	DESIRED WATER VAPOR PARTIAL PRESSURE		AVERAGE CRYOSURFACE TEMPERATURE NEEDED
torr	mbar	°C	torr	mbar	°C
$5 \times 10^0$	$6.7 \times 10^0$	-25.4	$5 \times 10^{-5}$	$6.7 \times 10^{-5}$	-104.9
$2 \times 10^0$	$2.7 \times 10^0$	-34.4	$2 \times 10^{-5}$	$2.7 \times 10^{-5}$	-109.1
$1 \times 10^0$	$1.3 \times 10^0$	-40.8	$1 \times 10^{-5}$	$1.3 \times 10^{-5}$	-112.2
$5 \times 10^{-1}$	$6.7 \times 10^{-1}$	-46.8	$5 \times 10^{-6}$	$6.7 \times 10^{-6}$	-115.1
$2 \times 10^{-1}$	$2.7 \times 10^{-1}$	-54.3	$2 \times 10^{-6}$	$2.7 \times 10^{-6}$	-118.1
$1 \times 10^{-1}$	$1.3 \times 10^{-1}$	-59.7	$1 \times 10^{-6}$	$1.3 \times 10^{-6}$	-121.5
$5 \times 10^{-2}$	$6.7 \times 10^{-2}$	-64.8	$5 \times 10^{-7}$	$6.7 \times 10^{-7}$	-124.1
$2 \times 10^{-2}$	$2.7 \times 10^{-2}$	-71.2	$2 \times 10^{-7}$	$2.7 \times 10^{-7}$	-127.5
$1 \times 10^{-2}$	$1.3 \times 10^{-2}$	-75.8	$1 \times 10^{-7}$	$1.3 \times 10^{-7}$	-129.9
$5 \times 10^{-3}$	$6.7 \times 10^{-3}$	-80.1	$5 \times 10^{-8}$	$6.7 \times 10^{-8}$	-132.2
$2 \times 10^{-3}$	$2.7 \times 10^{-3}$	-85.6	$2 \times 10^{-8}$	$2.7 \times 10^{-8}$	-135.2
$1 \times 10^{-3}$	$1.3 \times 10^{-3}$	-89.6	$1 \times 10^{-8}$	$1.3 \times 10^{-8}$	-137.3
$5 \times 10^{-4}$	$6.7 \times 10^{-4}$	-93.4	$5 \times 10^{-9}$	$6.7 \times 10^{-9}$	-139.5
$2 \times 10^{-4}$	$2.7 \times 10^{-4}$	-98.2	$2 \times 10^{-9}$	$2.7 \times 10^{-9}$	-142.1
$1 \times 10^{-4}$	$1.3 \times 10^{-4}$	-101.6	$1 \times 10^{-9}$	$1.3 \times 10^{-9}$	-144.1

## Key System Components

### 1 CRYOCOIL

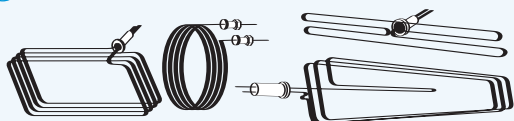

The cryocoil will be designed to fit the specific vacuum chamber, based on information you supply, or you may choose to design and build your own cryocoil. Typical cryocoils have helical, spiral, serpentine or other simple shapes. We do not recommend cryopanel; they slow the cool/defrost times due to increased mass and cryopump ineffectively on the rear side if positioned near the chamber wall. A stainless steel cryocoil, a complex cryocoil design or an adapter flange, may require additional costs.

### 2 FEEDTHROUGH

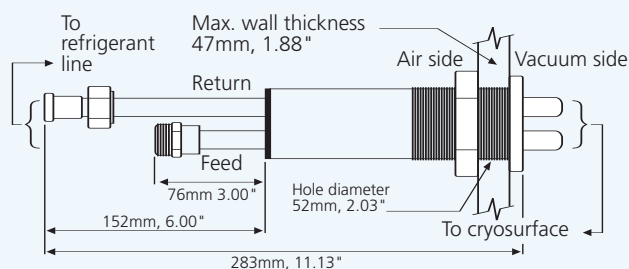

The standard cryogenic feedthrough provides thermal isolation between the feed/return tubes and the O-ring seal. The dual pass feedthrough requires a two-inch diameter hole in the vacuum chamber. Couplings on the feed-through mate with the refrigerant line. Optional feedthroughs fit one-inch diameter holes, but two are required (one for each tube). Custom feedthroughs are available.

### 3 REFRIGERANT LINE

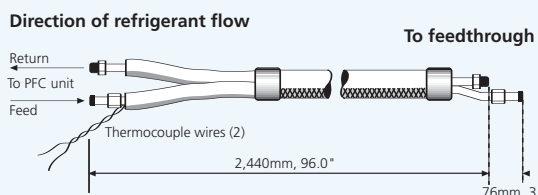

A standard refrigerant line set consists of a copper feed and return line, each with stainless steel couplings on both ends for connection to the PFC unit and to the feedthrough. Longer lengths of refrigerant line (more than the standard 8 feet (2.44m)) can be ordered from the factory. However, if the line length is longer than 15 feet (4.57m), it may be necessary to select the next larger PFC unit because of the additional heat load imposed by the longer line. Contact the factory for the cost of longer lines. Vacuum insulated lines may also be used.

*Model PFC Configurations (not to scale, standard refrigerant line is 8 feet)*

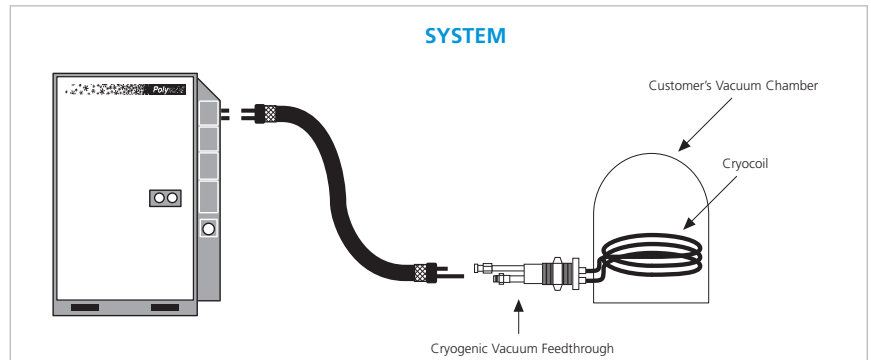
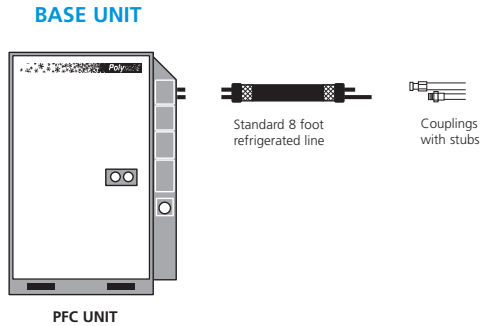

**PFC - Standard PFC Features:**

- Factory-charged with HCFC and CFC FREE refrigerant
- Temperature indicator with differential analog output
- Electronic controller to terminate defrost
- Control module for local manual control
- Remote connector to permit operation with your controller or your manual controls (Remote operation requires relays, switches, and wiring by end-users.)

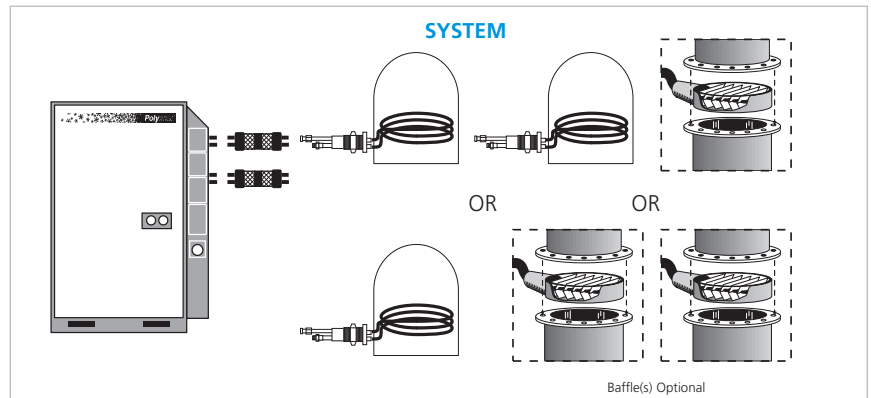
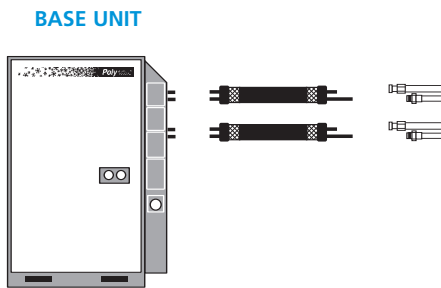

**PFC/PFC - Multi-Purpose PFC and PFC Features:**

- Includes all standard PFC features listed above
- The two cryosurfaces (consisting of: two cryocoils, coil and baffles or two baffles) can be cooled or defrosted separately. Total cooling capacity may be divided 1/2-1/2 or 2/3 - 1/3 between the two circuits. Note: (1) when one cryocoil is temperature-cycled, the baffle or other cryocoil temperature may vary up to 20°. (2) baffles not included in system price.

PFC/PFC Application Note: The intended application for a PFC/PFC configuration is for the operation of two cryocoils in different locations within a single in-line system. This configuration is also successful in the operation of cryocoils in two different load-locked systems. For batch systems we recommend a dedicated Polycold PFC per vacuum system.

*Helpful Information for Sizing Systems*

**Radiation Heat Load on Cryocoil**

- (At 25°C Ambient Conditions) -376.6 watts/m<sup>2</sup> (35 watts/ft<sup>2</sup>)
- Refrigerant Line Heat Load -26.3 watts/m (8 watts/ft)
- Vacuum Jacketed Line Heat Load -1.0 watts/m (0.3 watts/ft)
- Water Vapor Pumping Speed (Theoretical) - 149,000 l/s/m<sup>2</sup> (13,842 l/s/ft<sup>2</sup>)
- Liquid Nitrogen Cooling Approximately (45 watts/liter/hour)

**Simple Work Sheet**

Ultimate Base Pressure \_\_\_\_\_ Required Temperature: \_\_\_\_\_ C  
 Heat Load Cryocoil \_\_\_\_\_  
 Heat Load Refrigerant Line \_\_\_\_\_  
 Feedthrough 20 watts/feedthrough x # of feedthroughs \_\_\_\_\_  
 Additional Heat Load (Process Heat, etc.) \_\_\_\_\_  
 Total Heat Load \_\_\_\_\_

## Diagnostics & Controls for PFC, PFC/PFC 552, 672, 1102

The operator interface (Control Panel) pictured below is used on the PFC model PFC-552 and larger PFC systems. It illustrates most of the options available.

### Temperature

Included as standard in this module is a digital temperature meter (C) with a ten position thermocouple select switch (D). The switch allows monitoring of various temperatures within the system and at remote locations. Standard temperature monitoring points include:

1. Compressor Discharge
2. Refrigerant Liquid Line
3. Cryocoil Feet (circuit 1)\*
4. Cryocoil Return (circuit 1)\*
5. Cryocoil Feed (circuit 2)\*
6. Cryocoil Return (circuit 2)\*
7. Refrigerant Feed (circuit 1)
8. Refrigerant Return (circuit 1)
9. Coldest Liquid
10. Refrigerant Return (circuit 2)\*

\*Customer Assigned

Illustrated is an optional second temperature meter, set point relay and indicating lamp (A). The customer specifies the locations to be monitored with the set point relay and the meter. Not illustrated is an optional temperature set point relay with indicator lamp (B). The customer specifies the location to be monitored.

### System Control Module

Fault Lights/Controls: Flow Diagram

- Compressor Protection
- Dual Pressure Switch

(E) **Low Pressure Light** Indicates that the compressor suction pressure dropped too low (refer to operating manual).

(F) **High Pressure Light** Indicates that the compressor discharge pressure was too high (refer to Operating Manual).

(G) **Reset Button** Resets any fault indicated on system control once the problem has been corrected.

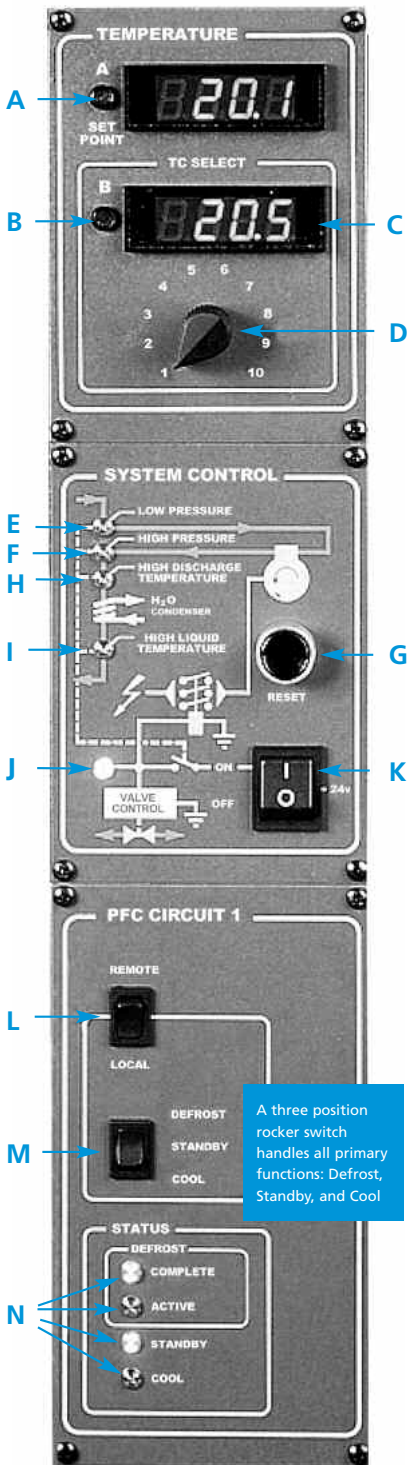

Model PFC Control Panel

(H) **Refrigerant Temperature High Discharge Temperature Light** indicates that the temperature of the refrigerant was too hot at the compressor discharge.

(I) **Cooling Water Supply High Liquid Temperature Light** Indicates loss of water, too little water, reversed flow or scale built-up inside the condenser.

(J) **Operating Indicator Light** Indicates the compressor contactor has activated and no faults are included.

### Compressor Power On/Off

(K) **On/Off Rocker Switch** AC Power Indicator Light (Located on High Voltage Box not shown). Indicates the Disconnect Switch is activated and AC power is on.

### PFC Circuit 1

PFC Circuit 2 includes the same features as Circuit 1 and is available on PFC/PFC Models.

### (L) Remote/Local Control Switch

The Remote feature allows the customer to control the PFC unit from a remote location via the customer's own equipment controller/computer. The local mode enables the Control Panel switches to be used to operate the unit.

(M) **Defrost/Standby/Cool Switch** When the previous Remote/Local Control Switch (L) is in the "Local" position, the three (3) position rocker switch initiates all primary functions: Defrost – Standby – Cool.

(N) **Status Lights** Indicates operation mode: defrost complete, defrost active, standby, cool.

*Options for Models PFC, PFC/PFC 552, 672, 1102*

*Temperature*

Indicates that the selected temperature is colder than the predetermined setpoint. Inside the module, the setpoint can be adjusted between -80C and -160C. When the temperature from the input thermocouple drops below the defined setpoint, a thermocouple limit switch lights a lamp on the panel and closes a relay contact which completes a circuit to the remote connector. Customer decides at time of purchase which location is to be dedicated to the setpoint.

- Part No. 600212-02

*Second Temperature Meter with Setpoint Relay*

Provides continuous readout of temperature and setpoint status for a second thermocouple position in a location of customer's choice.

- Part No. 600212-03

*Temperature Setpoint Relay and Second Temperature Meter with Setpoint Relay*

If you would like to order both of the previous two items, please specify:

- Part No. 600212-04

*Isolated Electrical Interface for User's Controller*

If you want to control the PFC unit remotely with other than switch closures, your control voltage and the PFC unit must be electrically isolated. To meet this requirement, the optional isolated relay interface is available in 6, 12, or 24 volts, 50/60 HZ AC or DC. (Specify desired voltage at time of order.)

- 24V Part No. 600248-01 (for Model PFC)
- 24V Part No. 600248-02 (for Model PFC/PFC)
- 24V Part No. 600248-03 (for Model PFC/Ps)

*Remote Temperature Indicator Meter*

This is a separate digital meter that is not installed in the PFC unit. It allows the user to read the analog output signal from the installed temperature meter at a remote control panel up to 50 feet away.

- Part No. 353010-01 (For voltage 115/1/60)
- Part No. 353010-02 (For voltage 230/1/60)
- Part No. 353010-03 (For voltage 24 volts)

*Remote Meter with 50 foot electrical cable*

- Part No. 840109-01 (For voltage 115/1/50-60)
- Part No. 840109-02 (For voltage 230/1/50-60)
- Part No. 840109-03 (For voltage 24/1/50/60)

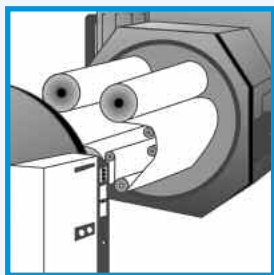

Rollcoating of Paper and Plastics

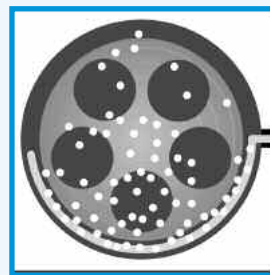

Semiconductor/optical deposition

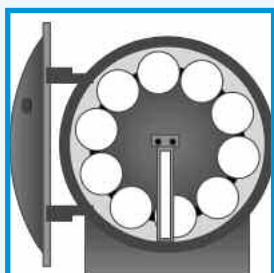

decorative/functional coating

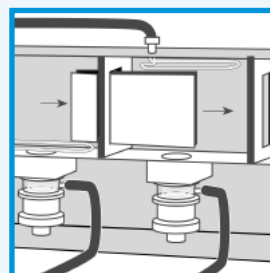

Magnetic disc /flat panel display deposition

*Comparison of Cryopumping Speed and Pressure - 60hz*

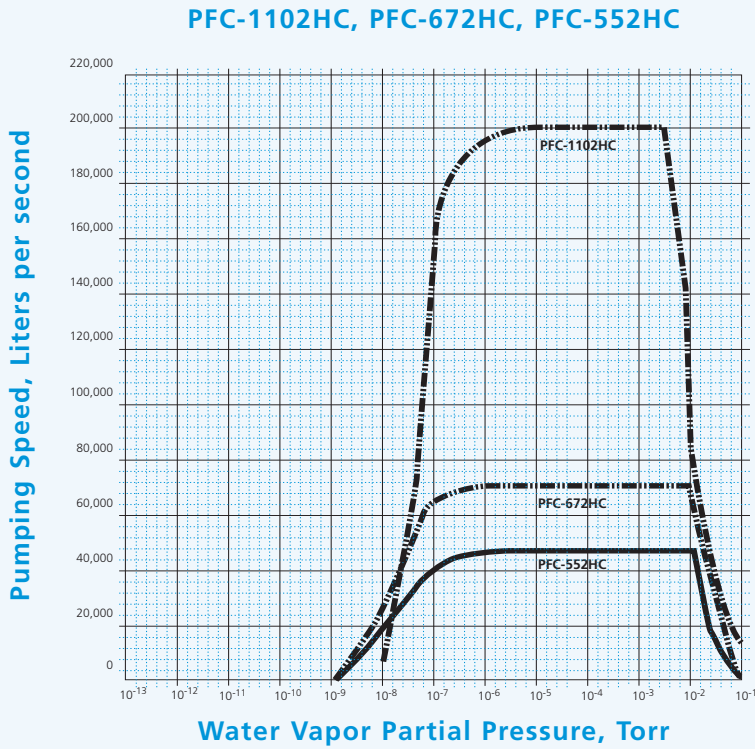

NOTE: For some operating conditions the cryocoils may be enlarged to provide greater pumping speeds

*Comparison of Average Temperature (A) and Cryosurface Temperature vs. Heat Load (B) - 60hz*

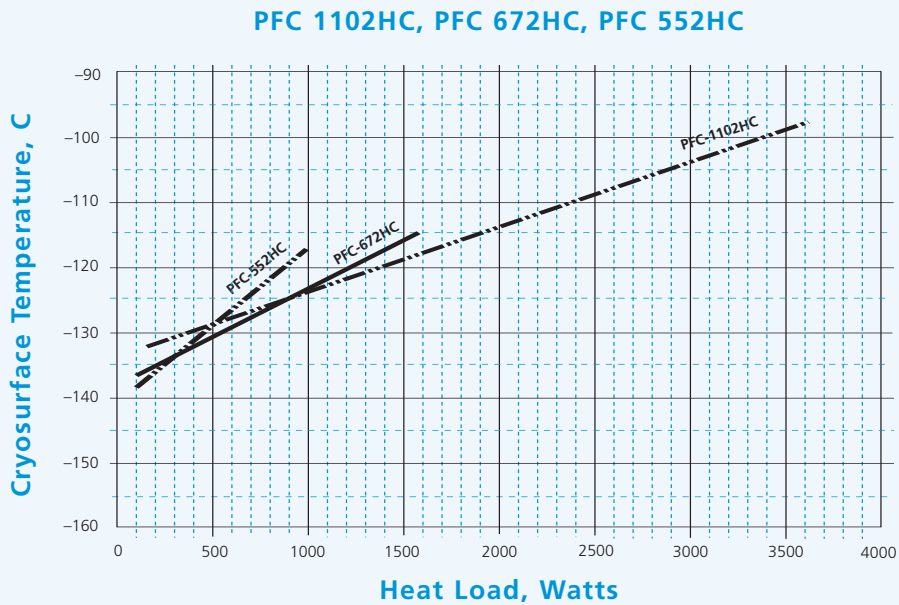

- NOTE:
1. Temperatures shown are the average of the inlet and outlet using recommended cryocoil size. The temperature differences between inlet and outlet are typically 20°C at Maximum load.
  2. The end point of each curve is the maximum load for that model.
  3. Performance at 50 Hz is typically 3 to 5°C warmer than the 60 Hz performance shown

## PFC Specifications

	552HC	672HC	1102HC
<b>Typical Performance<sup>a</sup></b>			
Maximum Load (Watts at warmest temperature)	1000	1500	3600
Theoretical max pumping speed l/sec <sup>b</sup>	74,500	104,300	298,000
Conservative pumping speed (in chamber) l/sec <sup>b</sup>	50,000	70,000	200,000
Ultimate Operating Pressure, torr <sup>c</sup>	2 x 10 <sup>-9</sup>	6 x 10 <sup>-9</sup>	3.0 x 10 <sup>-8</sup>
Ultimate Operating Pressure, mbar	3 x 10 <sup>-9</sup>	8 x 10 <sup>-9</sup>	4 x 10 <sup>-8</sup>
Maximum pump start pressure, atm <sup>d</sup>	1.0	1.0	1.0
Time to defrost, minutes	4.0	4.0	7.0 <sup>h</sup>

### Cryocoils and Refrigerant Lines

Total Cryocoil Surface area m <sup>2</sup> (ft. <sup>2</sup> )	0.5 (5.4)	0.7 (7.5)	2.0 (21.6)
Single Circuit (PFC)			
Tube O.D., mm (in.)	12 (1/2)	16 (5/8)	16 (5/8)
Tube Length m (ft.)	13.3 (41.1)	14 (46)	40 (132)
Dual Circuit (PFC/PFC)			
Tube O.D., mm (in.)	10 (3/8)	12 (1/2)	16(5/8)
Tube Length per coil, m (ft.)	7.96 (27.4)	9.28 (29)	20(66)
Standard refrigerant line lengths m (ft.)	2.44 (8)	2.44 (8)	2.44 (8)

### Utilities

Cooling water, flow rate l/min. (gal./min.)			
at 13C (55F)	4.9 (1.3)	6.8 (1.8)	13.6 (3.6)
at 26C (79F)	12.3 (3.2)	17.3 (4.6)	33.8 (8.9)
at 29C (85F)	19.7 (5.2)	27.6 (7.3)	54.1 (14.3)
Power Input, at maximum load, kW	6.0	8.3	19.2
Nominal Power Requirements <sup>e</sup>			
	200/3/50/60	200/3/50/60	200/3/50/60
	230/3/60	230/3/60	230/3/60
	380/3/50	380/3/50	380/3/50
	400/3/50	400/3/50	400/3/50
	460/3/60	460/3/60	460/3/60
	480/3/60	480/3/60	480/3/60
Max Operating Sound Level, dB(A) <sup>f</sup>	71	72	81
Minimum Room Volume m <sup>3</sup> (ft. <sup>3</sup> ) <sup>g</sup>	13 (460)	16 (570)	27 (955)

Footnotes: (a) Standard conditions for performance testing. (1) Cryocoil environment at 20°C (2) Recommend cryocoils and line lengths (3) Cooling water temperature between 25°C and 28°C. (4) Operation at 60 Hz. (b) Larger cryocoils may give greater pumping speeds, and can be used in some applications. Contact your sales representative or the factory for application details. (c) Standard cryocoil at twenty five percent (25%) of maximum pumping speed. (d) Recommended cryopump start pressure is near normal “crossover.” Mechanical roughing pumps and blowers are generally more effective for moisture removal above 1 torr. (e) For nominal power requirements not on the table, please contact the factory. Please refer to the manual for operational voltage ranges. For 480 volt operation the maximum voltage is 506. (f) Units were tested in a manufacturing environment while under maximum load in the COOL mode. (g) To comply with the Safety Code for Mechanical Refrigeration, ANSI/ASHRAE-15-1994, the following units should be located in a room no smaller than listed. (h) 7.0 minute maximum defrost is for a 2 m<sup>2</sup> coil. Most applications use smaller coils and achieve shorter defrost times. A 1 m<sup>2</sup> coil with standard refrigerant lines will defrost in less than 4 minutes.

Notes: All units have cryocoils that may be decoupled from the refrigerant lines and remote control capability with built-in remote connector. Maximum angle of inclination for shipping or handling all units is forty-five degrees (45°)

*PFC Dimensions and Weight (not to scale)*

**PFC 1102, PFC 672, PFC 552**

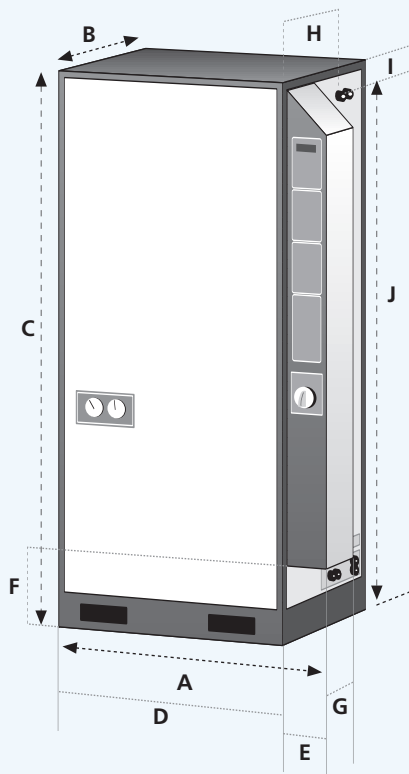

Model	A mm/Inches	B	C	D	E	F	G	H	I	J	Weight kg./lb.	Standard Refrigerant Line
<b>PFC 1102</b>	1054	711	1689	914	140	102	203	457	114	1562	544	8 ft.
	41.5	28	66.5	36	5.5	4	8	18	4.5	61.5	1200	2.44m
<b>PFC 672</b>	953	660	1842	812	140	254	203	432	114	1727	476	8 ft.
	37.5	26	72.5	32	5.5	10	8	17	4.5	68	1050	2.44m
<b>PFC 552</b>	953	660	1842	812	140	254	203	432	114	1727	408	8 ft.
	37.5	26	72.5	32	5.5	10	8	17	4.5	68	900	2.44m

“Combination” or “Multi-Purpose” PFC Models have the same dimensions as the “Standard PFC” Models in the equivalent size unit. (For example, a PFC/PFC 1102 has the same dimensions as a PFC 1102).

For PFC 552, PFC 672, and PFC 1102 (and corresponding “Combination” or “Multi-Purpose” PFC Models) allow 45 cm (18 inches) clearance for utilities, refrigerant line connection and controls on the right hand panel as seen viewing the front of the unit.

*For more information, please contact your local Brooks Automation sales representative or visit [www.brooks.com](http://www.brooks.com).*

